

Article number: 20414169AKNI

Description: E+G Stainless steel safety indexing plungers
GN 414.1-6-9-AK with safety mechanism, without rest position, with lock nut

Measures

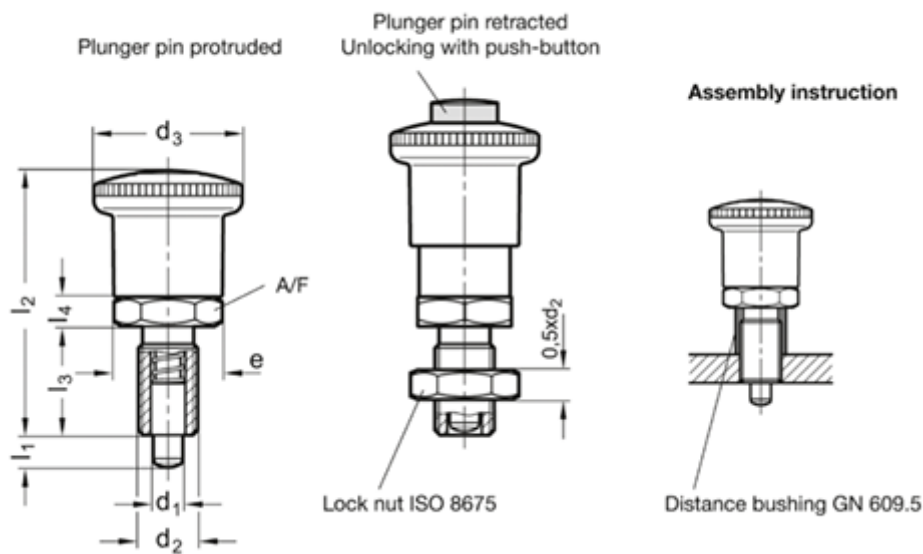

A/F	= 25	l2 ?	= 53.5
d1 Pin -0.02/-0.04 Bore H7	= 6	Weight in (g)	= 50
d2	= M 12 x 1.5		
d3	= 30		
e	= 21.9		
l3	= 22		
l4	= 6		
l1 min.	= 9		